





V82F

3~ 50 Hz. 400V	
FPT INDUSTRIAL	
EU STAGE 5	
69 dB(A) @ 7 mt	
400 lt	

PRIME POWER		STAND-BY POWER	
kVA	kW	kVA	kW
82	65,6	82	65,6

ENVIRONMENTAL CONDITIONS	
Temperature	40° C
Height	1000 mslm
Humidity	60%

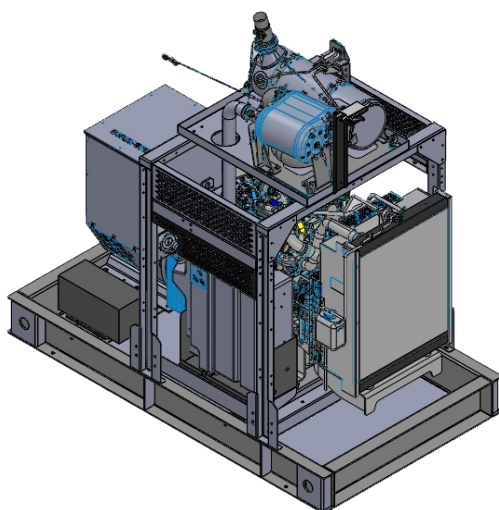
OPEN VERSION B100

SOUNDPROOF VERSION C100+

^L
The image is only for demonstration purposes

WEIGHT	DIMENSIONS		
	L [mm]	W [mm]	H [mm]
kg			
1450	2100	1000	1800

WEIGHT	DIMENSIONS		
	L [mm]	W [mm]	H [mm]
kg			
1700	2800	1150	1785

TECHNICAL DETAILS

ELECTRICAL DATA	Electrical system type	3F+N	~
	Power factor	0,8	φ
	Voltage	400	V
	Frequency	50	Hz
	PRP Ampere rating	118,4	A
ENGINE	Engine	FPT NEF F36ETVP03.A85	
	Engine emissions standard	EU STAGE 5	
	RPM governor	Electronic	
	Performance class	G3	
	Rpm	1500	rpm
	Nr. of cylinders	4	
	Bore x stroke	102 x 110	mm
	Displacement	3595	cc
	Induction system	Turbocharged	
	Cooling system	Water	
	Engine net prime power	106,8 (81,6)	Hp (kW)
Exhaust gas aftertreatment	DOC + DPF + SCR		
CONSUMPTION	Fuel type	Diesel	
	Consumption @ 50-75-100% - load - charge	10,7 - 15,7 - 20,9	lt/h
	Standard tank capacity	400	lt
	Autonomy - @ 75% carico - load - charge	25,5	h
	AdBlue tank capacity	43	lt
	AdBlue autonomy - @ 100% carico - load - charge	49	h
ALTERNATOR	Alternator -	STAMFORD - MECC ALTE - MARELLI MOTORI	
	Type	Self excited, brushless	
	Number of poles	4	
	Insulation class	H	
	Temperature rise class	H	
	Voltage regulation	AVR	
	Voltage precision	± 1	%
GENERAL	Sound level (soundproof version)	69	dB(A) 7mt
	Exhaust pipe diameter	60	mm
	Electrical system voltage	12	V

ELECTRIC PANEL

MANUAL

AUTOMATIC MAINS FAILURE

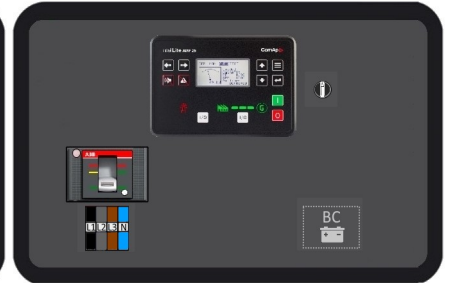
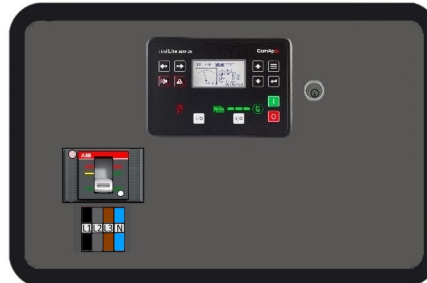

Electronic control unit with multimeter	COMAP IntelliLite4 AMF25	
Electrical panel enclosure protection degree	IP44	
ON-OFF electric panel switch	Key type	Without key
Emergency pushbutton	STANDARD	
Battery charge maintainer	/	12V 5A
Power supply	Full power terminal	
Circuit breaker	Magnetothermal type 4P ABB Tmax-XT 125A	
Main protection alarms	Min-max V and Hz. LOP. HWT. Battery charger alternator failure. Low fuel level	

STANDARD ELECTRONIC CONTROL UNIT

COMAP
IntelliLite4 AMF25



Functions: automatic or manual start, remote start, periodic test

Multimeter V (L1, L2, L3, N), A (L1, L2, L3), Hz, kVA, battery V, hour counter

Backlit LCD display. USB port

Communication accessories available: Ethernet, GSM-GPRS, 4G, GPS

MODBUS and SNMP communication protocols support

Advanced PLC configurability



OPTIONAL ELECTRONIC CONTROL UNIT

SOUNDPROOF AND WEATHERPROOF CANOPY

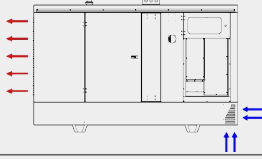

Self-supporting frame material	Carbon steel sheet, electro-welded, minimum thickness 2,5 mm
Soundproof canopy material	Carbon steel sheet, electro-welded, thickness between 1,5 and 5,5 mm
Painting	Polyester powder RAL5015 textured, outdoor-proof
In-built fuel tank	400 lt + Drip tray
Soundproofing coating material	Polyester fiber. Fire resistance EN13501-1 class B
Muffler	In-built the canopy. Residential type with sound reduction 35 dB(A)
Access openings	n.3 doors with key lock
Electric panel	Lateral side position. Dedicated door with key lock
Fresh air intake and hot air expulsion	
Lifting system	n.2 lifting hooks
Support feet	n.4 support feet with holes for machine ground fastening

CONTAINER TRANSPORTABILITY ADVANTAGES

VERSION		20' BOX	40' BOX	40' HC
	N. transportable pieces	5	10	10
		4	8	8

MAIN OPTIONS



140A automatic transfer switch (ATS)



800 lt bigger fuel tank with drip tray



750W engine preheating system



Automatic fuel transfer kit with manual by-pass system



Residual current protection relay adjustable in sensitivity and intervention time

OTHER OPTIONS

Power distribution socket set
Synchronizing electric panel
Battery switch
Remote control systems – **ETHERNET, 2G - 3G - 4G, GPS**

Further alternator brand –
Quick couplings for connecting an external tank with three way valve
Outdoor, underground and transportable tanks
Slow or fast towing trailer
Front hot air expulsion canopy
Further colors

VERSIONS WITH SPECIAL EQUIPMENT



RENTAL

Special version with features designed for the rental market



ZERO NOISE

Super sound-proofed special version, noise level 50, 55 or 60 dB(A)



Greenpower AB

Helsingborgsvägen Varalöv

262 96 Ängelholm

Tel: 0431 222 40

Fax: 0431 222 70

E mail: info@greenpower.se

web: www.greenpower.se